

# KIT GUIA DESLIZANTE MASSIMA S NYL

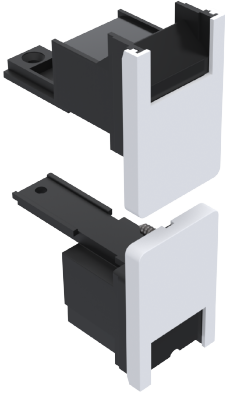

## CARACTERÍSTICAS

| CODIFICAÇÃO |         |                 |
|-------------|---------|-----------------|
| COR         | CÓDIGO  | CATÁLOGO        |
| BCO         | 9302771 | KITGUIMASSNYBCO |
| CZA         | 9302772 | KITGUIMASSNYCZA |
| PRT         | 9302773 | KITGUIMASSNYPRT |

### OBSERVAÇÕES

#### COMPOSIÇÃO/CARACTERÍSTICAS:

- GUIA E TAMPA: POLÍMERO;
- PARAFUSOS: AÇO INOX.

## APLICAÇÃO

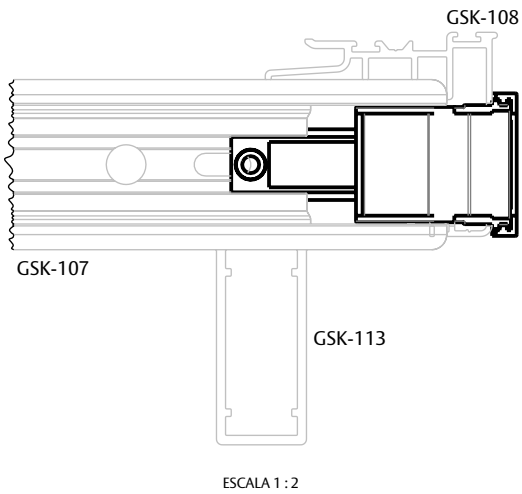

## DIMENSÕES

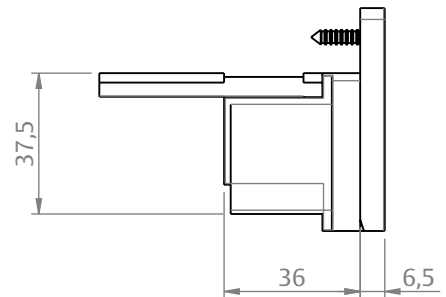
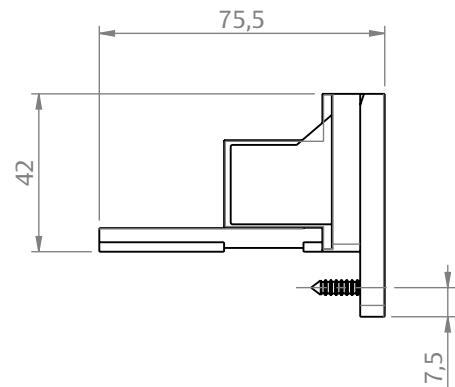
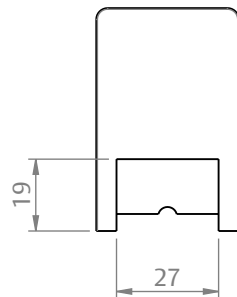
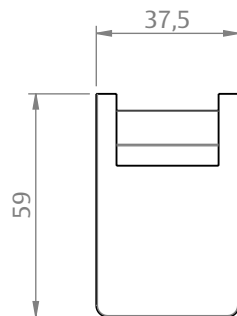

ESCALA 1:2

PORTA DE CORRER

LOCK S

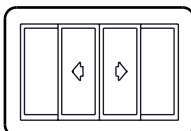

**UDINESE**  
**ASSA ABLOY**

# KIT GUIA DESLIZANTE MASSIMA S NYL

## USINAGENS

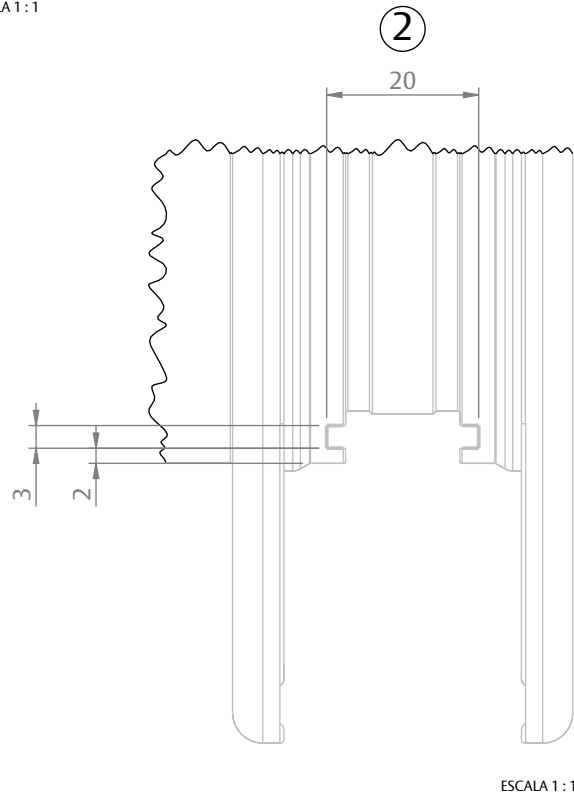
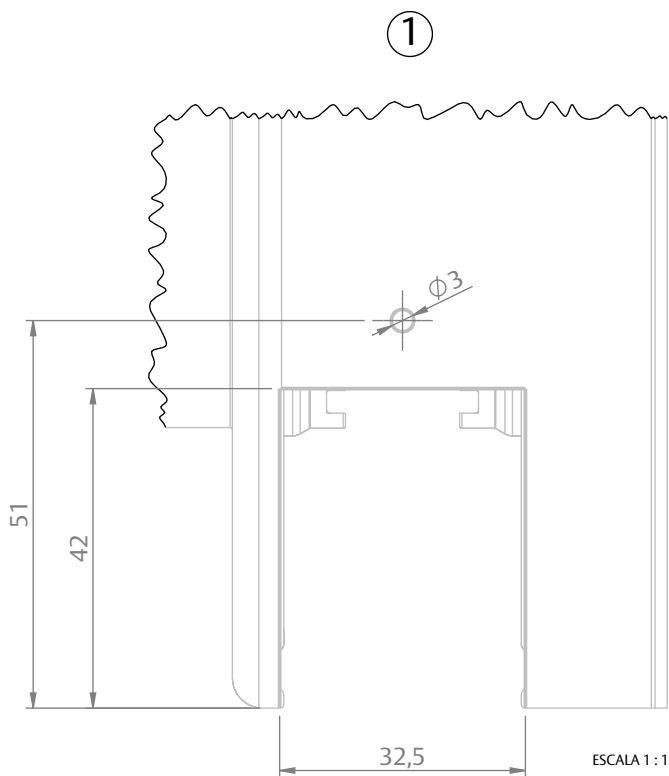
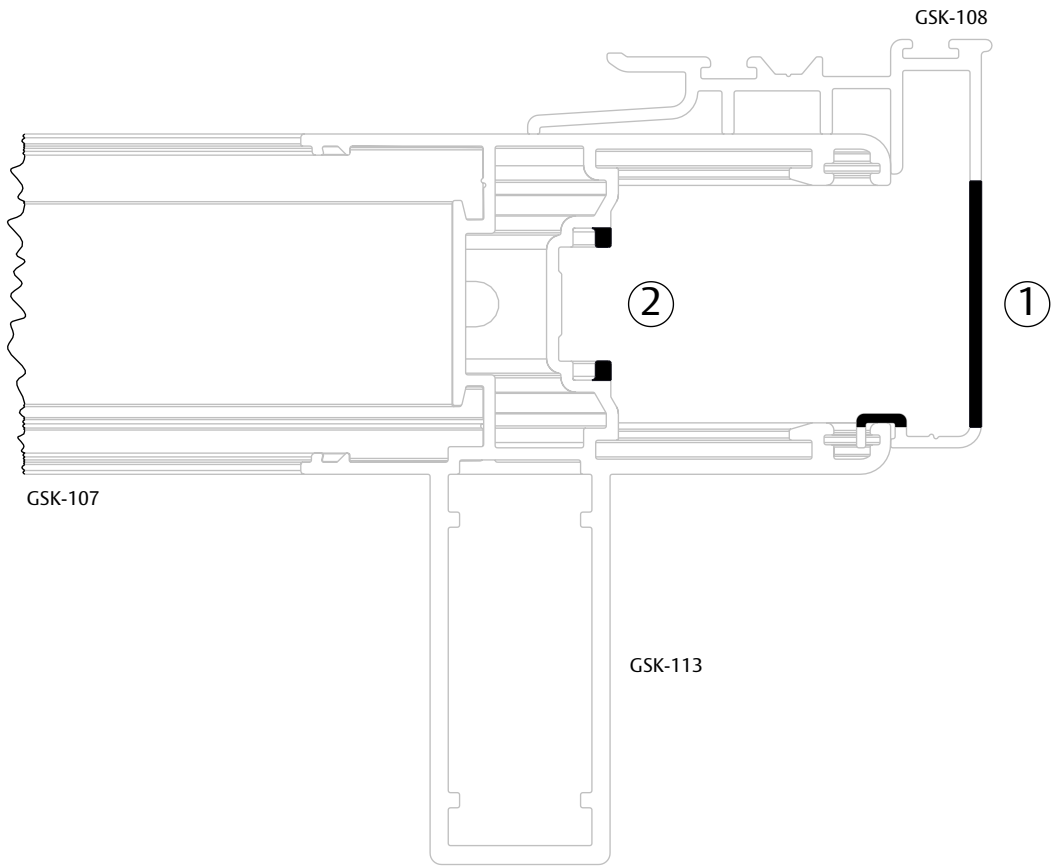

**UDINESE**  
**ASSA ABLOY**