

CONTRA FECHO CONCHA SD2504

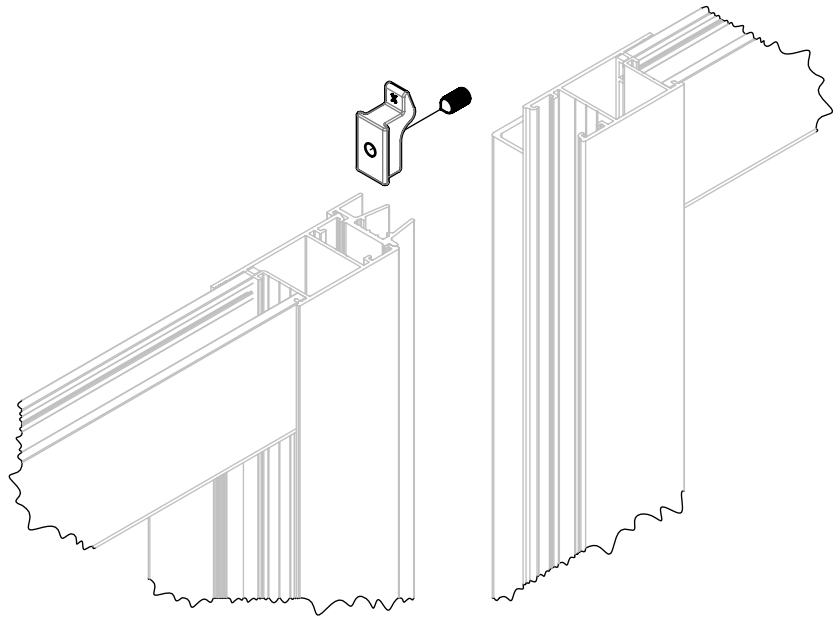

APLICAÇÃO



SEM ESCALA

CARACTERÍSTICAS

CODIFICAÇÃO		
CONTRA FECHO CONCHA SD2504 - POLÍMERO		
COR	CÓDIGO	CATÁLOGO
BCO	9209008	CTFSD2504UDBCO1PC
PRT	9209007	CTFSD2504UDPRT1PC
CONTRA FECHO CONCHA SD2504 - ZAMAK		
BCO	9212703	CTFSD2504ZAMBCO1PC
PTF	9212704	CTFSD2504ZAMPFT1PC

OBSERVAÇÕES

COMPOSIÇÃO/CARACTERÍSTICAS:

- CONTRA FECHO: POLÍMERO/ZAMAK;
- PARAFUSO: AÇO INOX.

DIMENSÕES

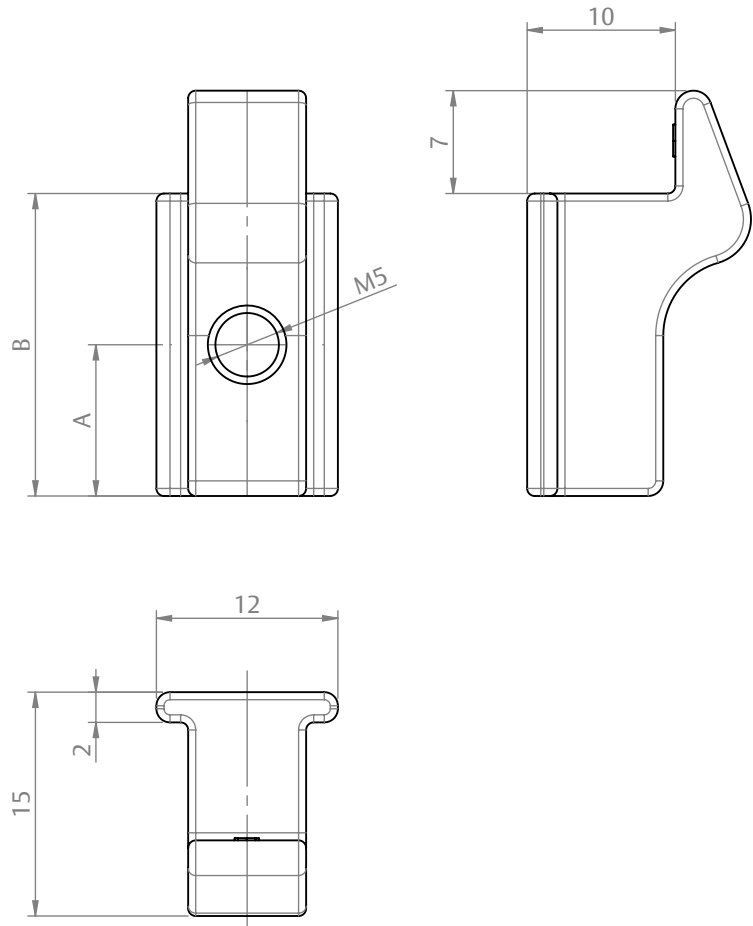

MATÉRIA PRIMA	COTA A (mm)	COTA B (mm)
POLÍMERO	10	20
ZAMAK	8,5	23

ESCALA 2 : 1

PORTA E JANELA
DE CORRER

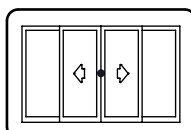

UDINESE
ASSA ABLOY

CONTRA FECHO CONCHA SD2504

APLICAÇÕES

**ECOLINE 2.5
(PERFIL)**

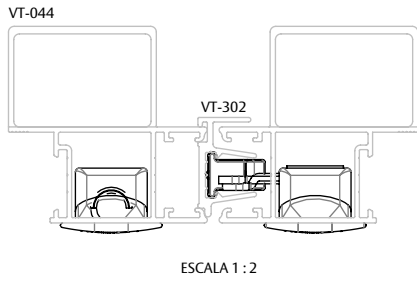

**UNNION
(PERFIL)**

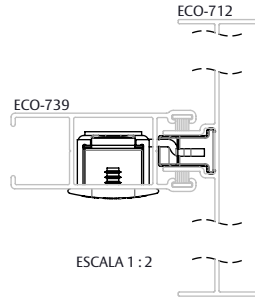

**SUPREMA
(HYDRO)**

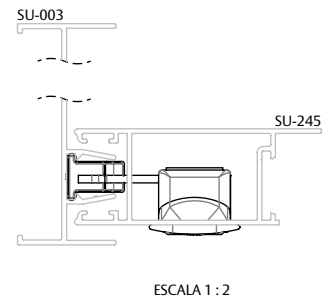

**MASTER
(HYDRO)**

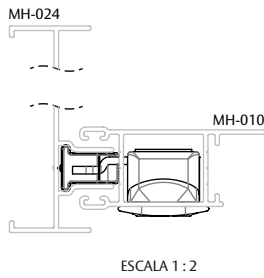

**INOVA
(HYDRO)**

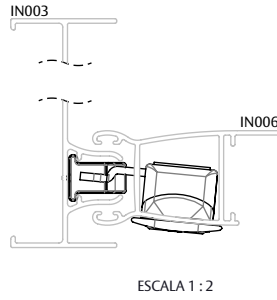

**OFFICIAL
(HYDRO)**

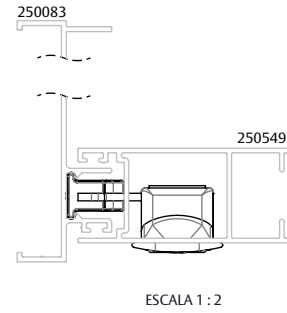

**IMPERIAL 2.5
(BELMETAL)**

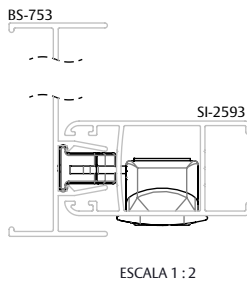

**AGLO 2.0
(OLGA COLOR)**

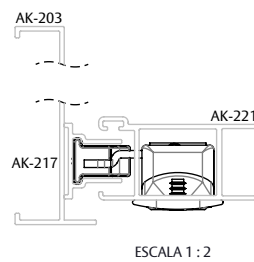

**AGLO 3.2
(OLGA COLOR)**

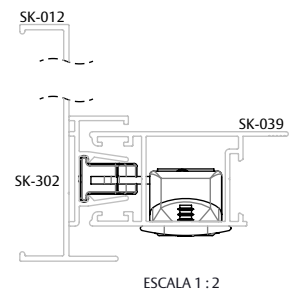

**MEGA 20
(ASA ALUMÍNIO)**

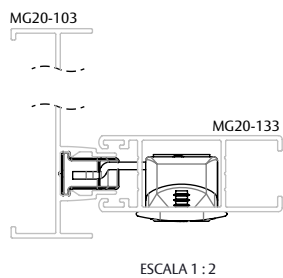

**MEGA 25
(ASA ALUMÍNIO)**

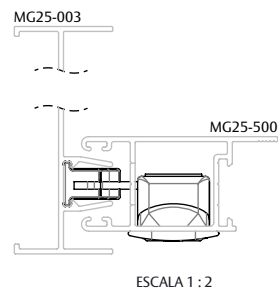

**SP20
(SELTA)**

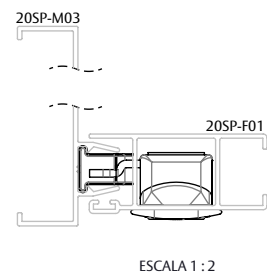

UDINESE
ASSA ABLOY