

# FECHO CONCHA 7611

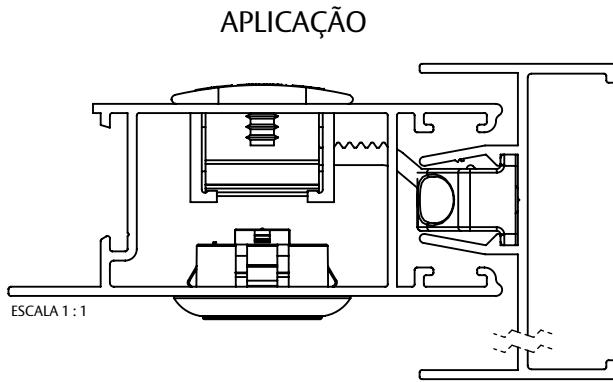

## CARACTERÍSTICAS

| CODIFICAÇÃO         |         |               |            |
|---------------------|---------|---------------|------------|
| FECHO CONCHA 7611/A |         |               |            |
| COR                 | CÓDIGO  | CATÁLOGO      | SISTEMISTA |
| BCO                 | 9211388 | CON7611ATHBCO | CON-7611   |
| BP3                 | 9211389 | CON7611ATHBP3 |            |
| PRA                 | 9211390 | CON7611ATHPRA |            |
| PTF                 | 9211391 | CON7611ATHPTF |            |
| INX                 | 9211392 | CON7611ATHINX |            |

| CODIFICAÇÃO               |         |                |            |
|---------------------------|---------|----------------|------------|
| FECHO CONCHA 7611/A/CHAVE |         |                |            |
| COR                       | CÓDIGO  | CATÁLOGO       | SISTEMISTA |
| BCO                       | 9211393 | CON7611ACTHBCO | CON-7611   |
| BP3                       | 9211394 | CON7611ACTHBP3 |            |
| PRA                       | 9211395 | CON7611ACTHPRA |            |
| PTF                       | 9211396 | CON7611ACTHPTF |            |
| INX                       | 9211397 | CON7611ACTHINX |            |

| CONTRA FECHO  |          |
|---------------|----------|
| BCO - 9210380 | POLÍMERO |
| PRT - 9210376 |          |

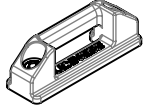

| LINGUETA      |
|---------------|
| S/A - 9210395 |



### OBSERVAÇÕES:

- CONTRAFECHO E LINGUETA VENDIDOS SEPARADAMENTE.

### COMPOSIÇÃO/CARACTERÍSTICAS:

- CONCHA/ INTERNO/ PINO: ALUMÍNIO;
- INCADOR/TRAVA CONCHA : POLÍMERO;
- MOLA/ PARAFUSOS/CILINDRO/CHAVE:INOX.

JANELA DE CORRER  
SUPREMA

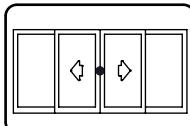

## DIMENSÕES

FECHO CONCHA 7611/A

FECHO CONCHA 7611/A/CHAVE

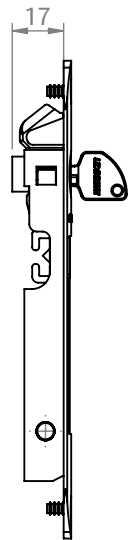
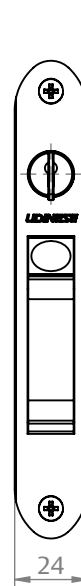
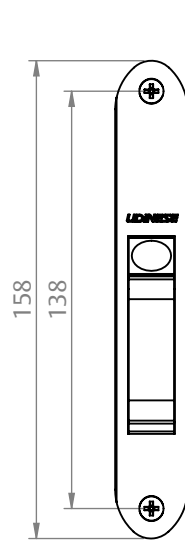

ESCALA 1 : 2,5

## USINAGEM

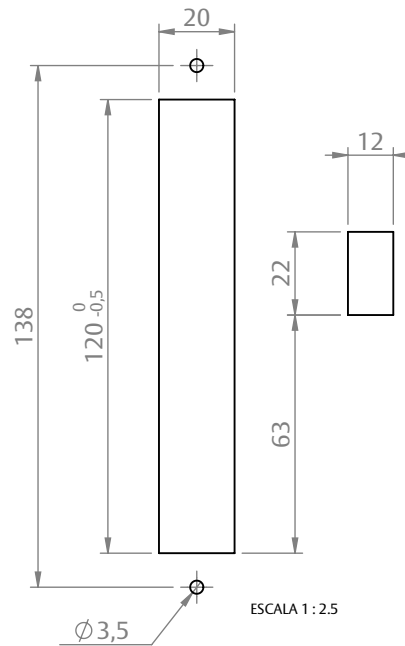

ESCALA 1 : 2,5

**UDINESE**  
**ASSA ABLOY**

# FECHO CONCHA 7611 SEM PARAFUSO

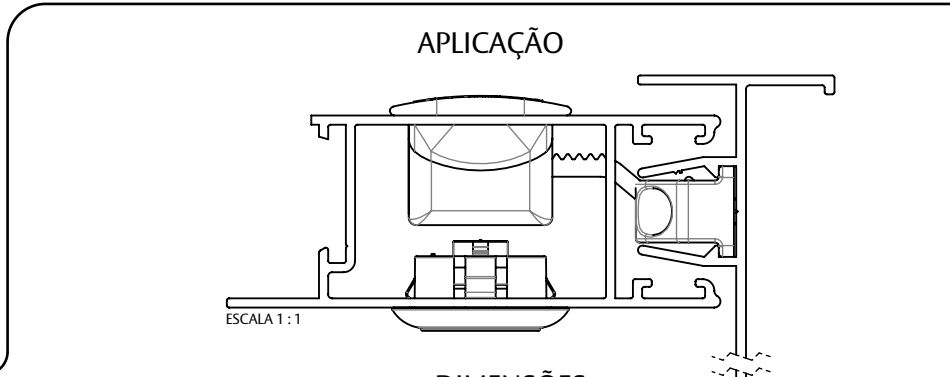
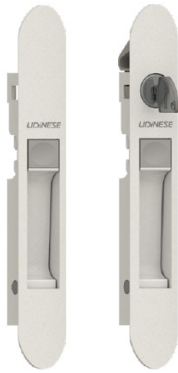

## CARACTERÍSTICAS

| CODIFICAÇÃO                      |         |                     |            |
|----------------------------------|---------|---------------------|------------|
| FECHO CONCHA 7611/A SEM PARAFUSO |         |                     |            |
| COR                              | CÓDIGO  | CATÁLOGO            | SISTEMISTA |
| BCO                              | 9211403 | CON7611ATHSPARFBCO  | CON-7611   |
| BP3                              | 9211404 | CON7611ATHSPARFBP3  |            |
| PRA                              | 9211405 | CON7611ATHSPARFPRA  |            |
| PTF                              | 9211406 | CON7611ATHSPARFP TF |            |
| INX                              | 9211407 | CON7611ATHSPARFINX  |            |

| CODIFICAÇÃO                            |         |                      |            |
|--|---------|----------------------|------------|
| FECHO CONCHA 7611/A/CHAVE SEM PARAFUSO |         |                      |            |
| COR                                    | CÓDIGO  | CATÁLOGO             | SISTEMISTA |
| BCO                                    | 9211408 | CON7611ACTHSPARFBCO  | CON-7611   |
| BP3                                    | 9211409 | CON7611ACTHSPARFBP3  |            |
| PRA                                    | 9211410 | CON7611ACTHSPARFPRA  |            |
| PTF                                    | 9211411 | CON7611ACTHSPARFP TF |            |
| INX                                    | 9211412 | CON7611ACTHSPARFINX  |            |

| CONTRA FECHO  |          |
|---------------|----------|
| BCO - 9210380 | POLÍMERO |
| PRT - 9210376 |          |

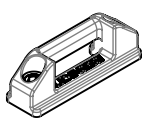

| LINGUETA      |
|---------------|
| S/A - 9210395 |

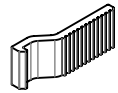

### OBSERVAÇÕES:

- CONTRAFECHO E LINGUETA VENDIDOS SEPARADAMENTE.

### COMPOSIÇÃO/CARACTERÍSTICAS:

- CONCHA/ INTERNO/ PINO: ALUMÍNIO;  
 - INCADOR/TRAVA CONCHA : POLÍMERO;  
 - MOLA/CILINDRO/CHAVE:INOX.

FECHO CONCHA 7611/A SEM PARAFUSO

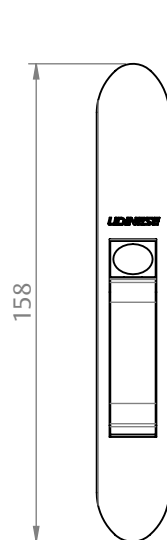

FECHO CONCHA 7611/A/CHAVE SEM PARAFUSO

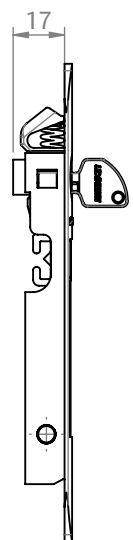
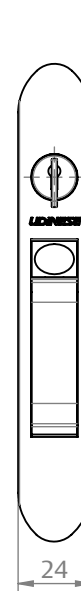

ESCALA 1 : 2,5

## USINAGEM

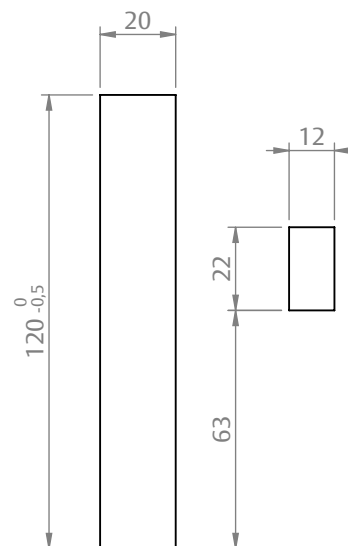

ESCALA 1 : 2,5

JANELA DE CORRER SUPREMA

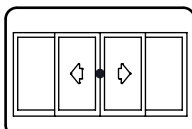

**UDINESE**  
**ASSA ABLOY**

# FECHO CONCHA 7611

## INSTRUÇÃO DE MONTAGEM

O INDICADOR DEVE SER MONTADO APÓS O AJUSTE DA LINGUETA, SUA FUNÇÃO É IMPEDIR QUE O PARAFUSO FIQUE APARENTE.

CASO SEJA NECESSÁRIO A REMOÇÃO DO INDICADOR, FORCE-O PELO LADO INFERIOR UTILIZANDO UM OBJETO PONTIAGUDO.

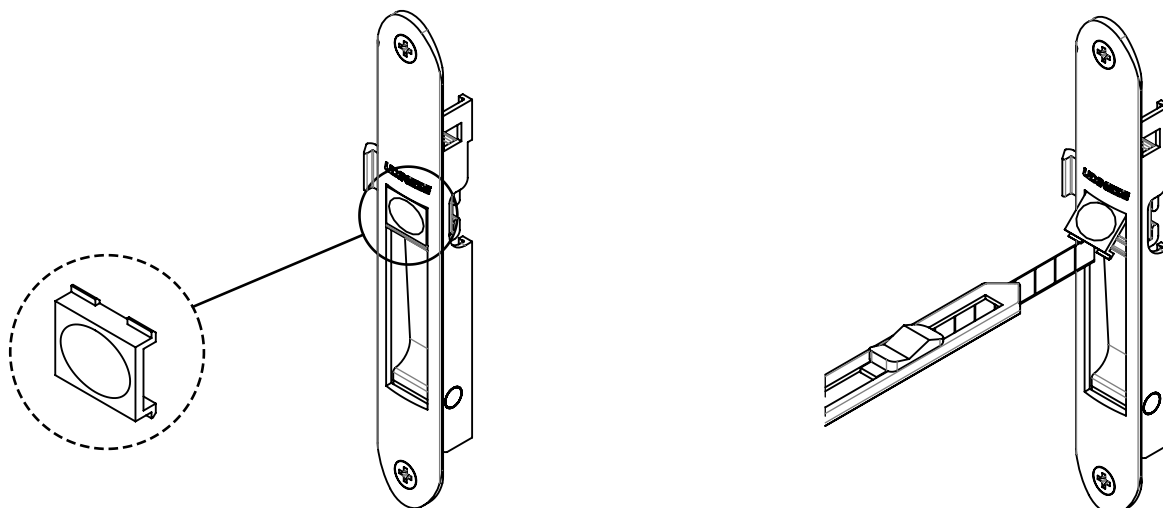

## MONTAGEM DO INDICADOR

1. ENCAIXAR A PARTE SUPERIOR DO INDICADOR NO INTERNO DO FECHO CONCHA. CONFORME ILUSTRAÇÃO DA FIG.1:
2. APÓS O ENCAIXE DA PARTE SUPERIOR, PRESSIONAR O INDICADOR NA DIREÇÃO E SENTIDO DE F2 ATÉ QUE A PEÇA SEJA CLICADA NO INTERNO CONFORME FIGURAS 1 E 2.

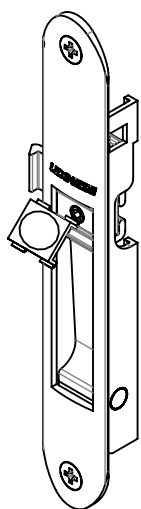

FIG. 1

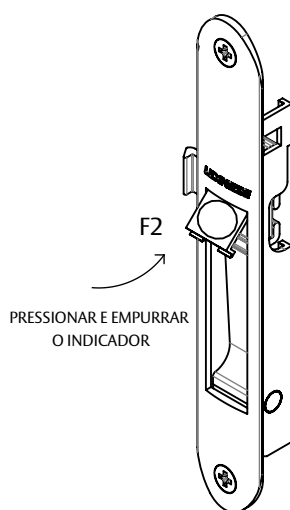

FIG. 2

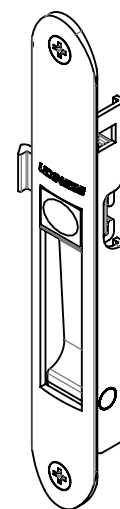

FIG. 3

**UDINESE**  
**ASSA ABLOY**