

GUIA LIMITADOR GUI203

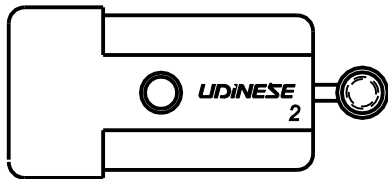

Aplicação

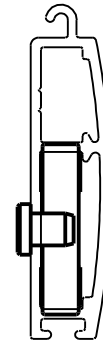

Características

Componente	Matéria-prima
Guia	Polímero

Embalagem	20 Guias
-----------	----------

Codificação		
Cor	Udinese	Catálogo
PRT	9301173	GUI203NYE20

GUIA

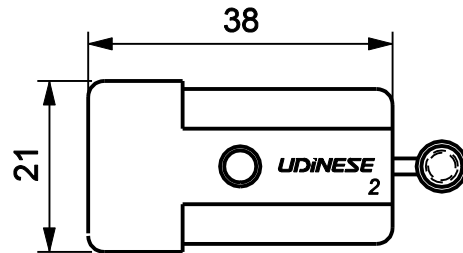
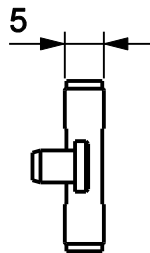

ESCALA 1:1

USINAGEM

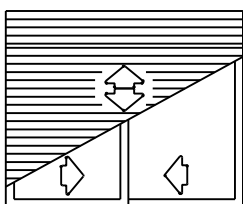
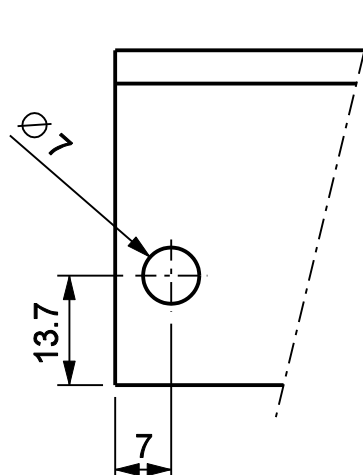
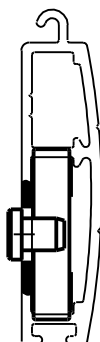

PERSIANAS
LUNA

*Todas as medidas em mm

UDINESE

220.25.4