

ROLDANA PEDRA SIMPLES | DUPLA CÔNCAVA GOLD

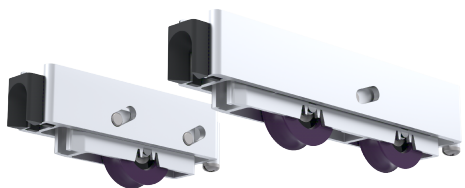

APLICAÇÃO

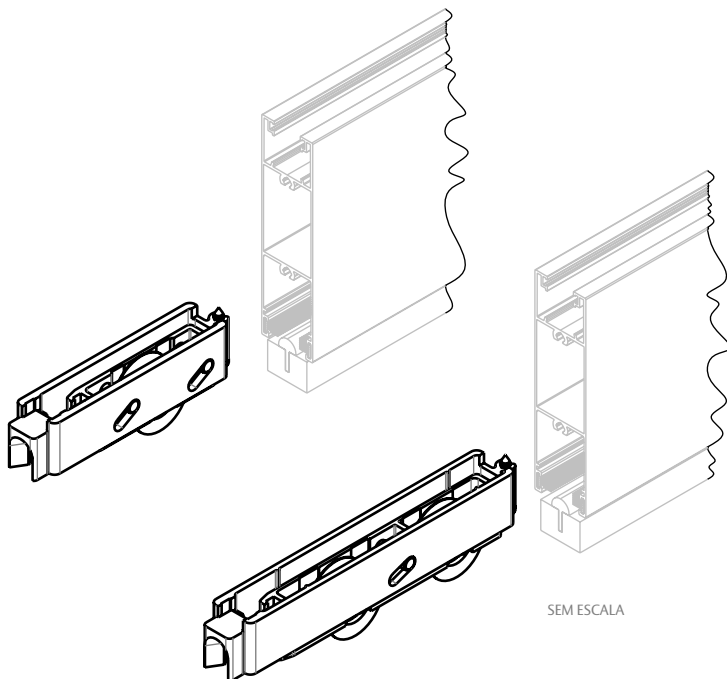

CARACTERÍSTICAS

ROLDANA SIMPLES PEDRA			
COR	CÓDIGO	CATÁLOGO	CARGA MÁXIMA
S/A	9500531	ROLSIMPEDRCGLD1PC	50 kg P/ ROLDANA
ROLDANA DUPLA PEDRA			
COR	CÓDIGO	CATÁLOGO	CARGA MÁXIMA
S/A	9500507	ROLDUPPEDRCGLD1PC	100 kg P/ ROLDANA

OBSERVAÇÕES

- TRILHO NÃO FORNECIDO PELA UDINESE.

COMPOSIÇÃO/CARACTERÍSTICAS:

- CAIXA, GARFO, LOCALIZADOR E PINO ESPAÇADOR: ALUMÍNIO;

- PINO SUPORTE E PARAFUSOS: AÇO INOX.

DIMENSÕES ROLDANA SIMPLES

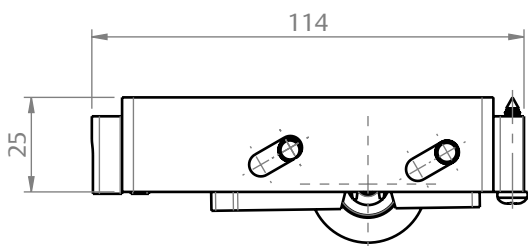

ESCALA 1:2

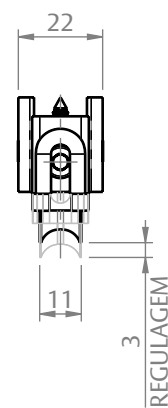

DIMENSÕES ROLDANA DUPLA

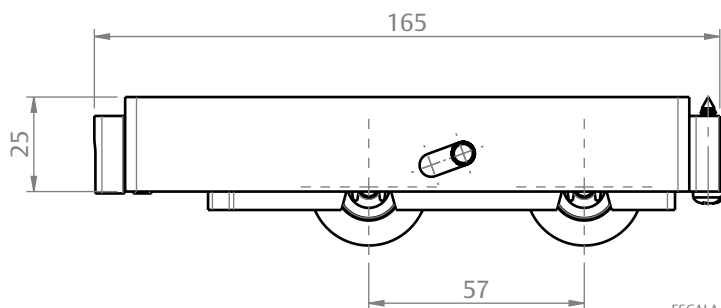

ESCALA 1:2

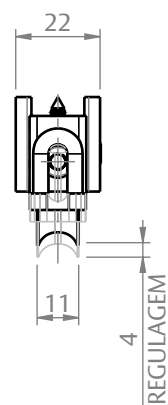

PORTA DE CORRER

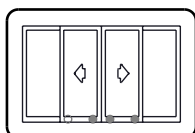

UDINESE
ASSA ABLOY

ROLDANA PEDRA SIMPLES | DUPLA CÔNCAVA GOLD

APLICAÇÕES

CHROMA
(PERFIL ALUMÍNIO)

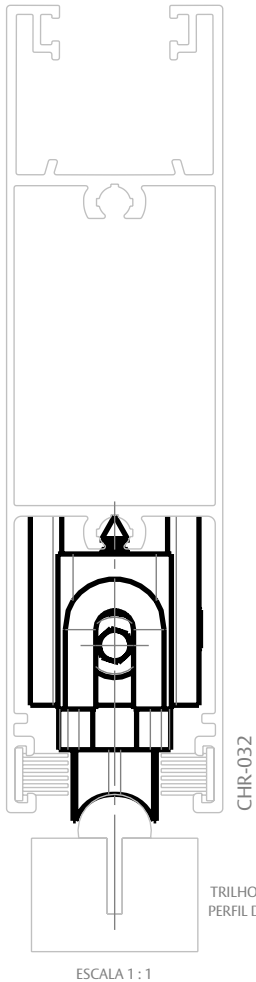

CHROMA MINIMALISTA
(PERFIL ALUMÍNIO)

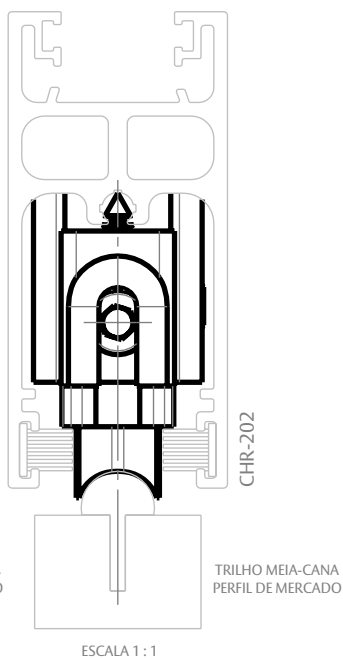

GOLD
(HYDRO)

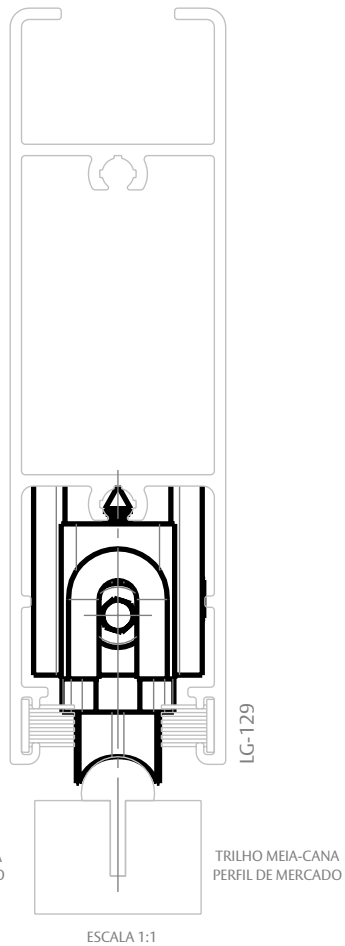

ELEGANCE
(HYDRO)

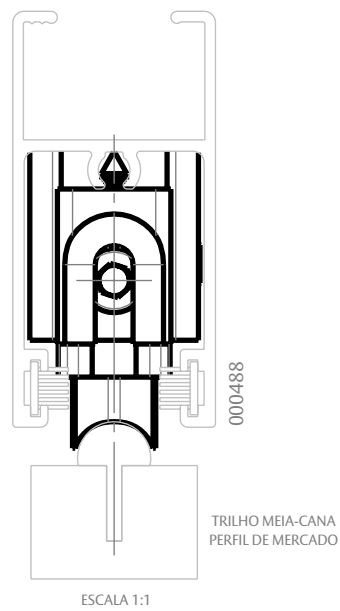

ROLDANA PEDRA SIMPLES | DUPLA CÔNCAVA GOLD

APLICAÇÕES

D'ORO
(CDA)

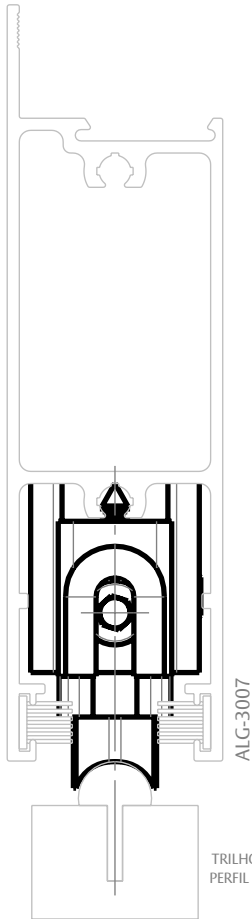

ESCALA 1:1

MEGA 32
(ASA ALUMÍNIO)

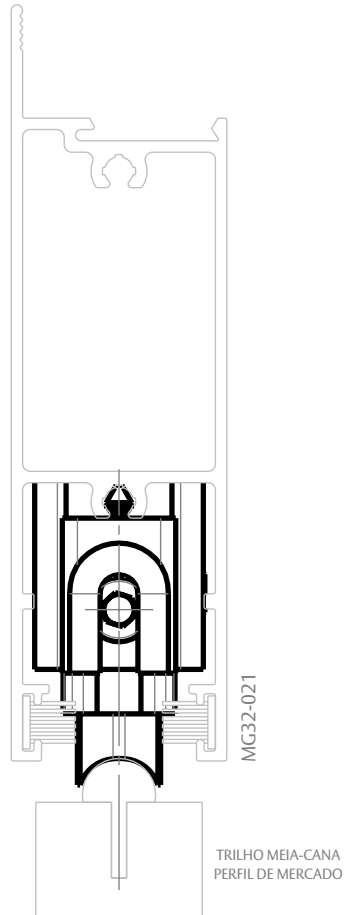

ESCALA 1 : 1

ESCOVA REBAIXADA

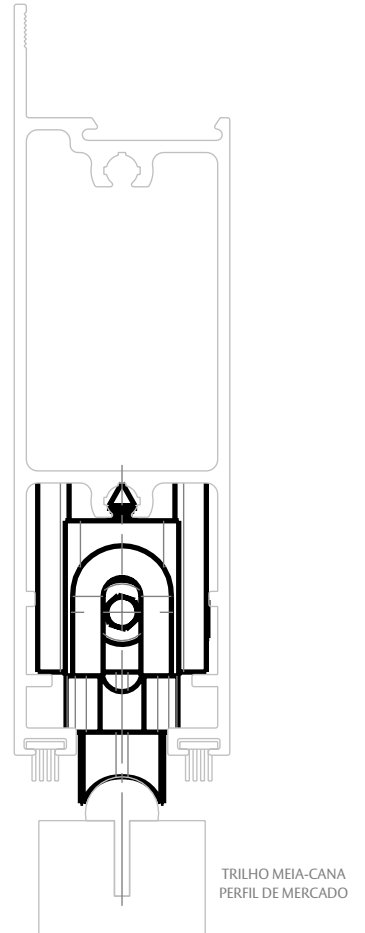

ESCALA 1 : 1