

TRAVA FOLHA FIXA SP803

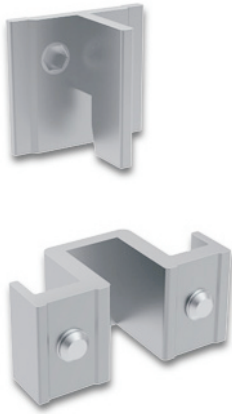

Aplicação

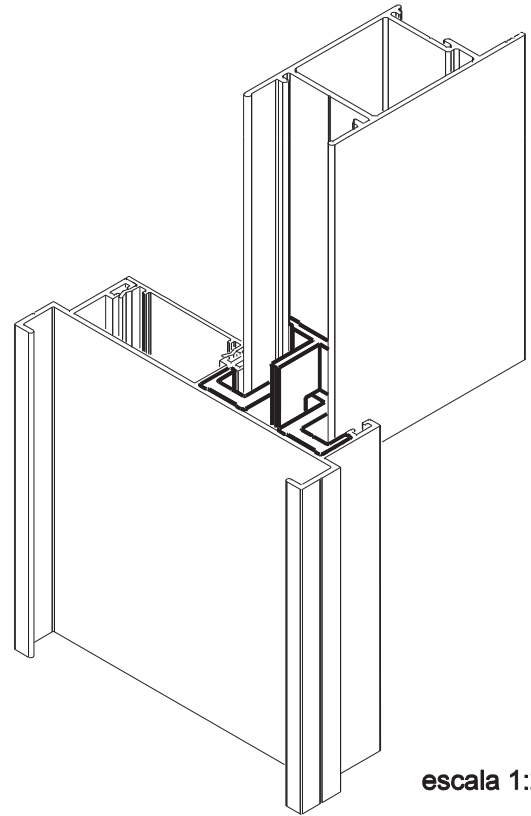

escala 1:2

Características

Componentes	Matéria-prima
Trava "T"	Alumínio
Trava "E"	Alumínio
Parafuso	Inox

Componente de fixação	Dimensão	Qtde.
Parafuso	M6x7 allen/s.cab/inox	3/pç

Embalagem	2 travas "E"
	2 travas "T"
	6 parafusos

Cor	Codificação		
	Udinese	Catálogo	Alcoa
S/A	9300140	TRASP803E2	SUP-622

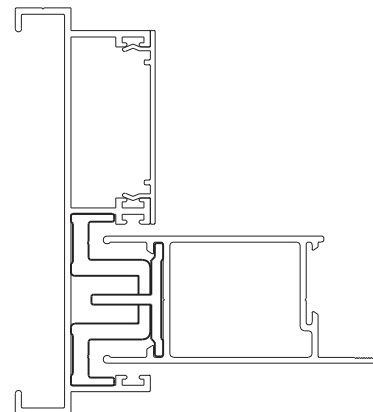

escala 1:2

TRAVA "E"

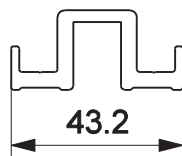

TRAVA "T"

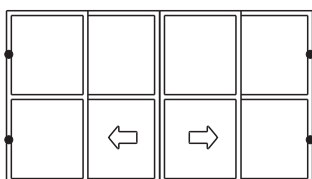
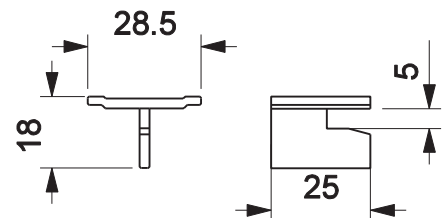

JANELA OU PORTA DE CORRER
LINHA GOLD

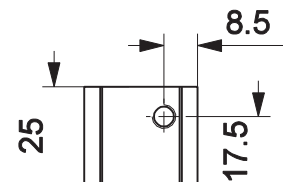
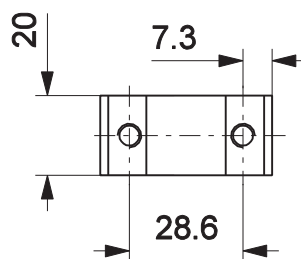

escala 1:2

UDINESE